



AGRICULTURE FILTRATION

HARD WORK
IT'S IN OUR BLOOD

WERE YOU BORN IN A BARN?

Maybe not, but farming is in your blood. You work hard every day. It's a tough life, with plenty to worry about. You shouldn't have to worry about filtration. Let Baldwin make it easier. Baldwin has been around for generations. We have the coverage, quality, service and dependability you need. Whether you're in the fields 24/7 or hauling valuable cargo, Baldwin has what it takes to be your one-source filter provider and keep your trucks and equipment running when you need them.



QUALITY

When it comes to protecting your equipment, you don't settle for anything but the best. Neither does Baldwin. Every phase of production, from raw material purchase to final inspection, is designed to ensure the highest quality and performance standards.

SERVICE

Getting an honest answer is important to you. Baldwin agrees. We value your trust and work hard to provide the support and answers you deserve. With the largest, most experienced field sales and support team in the industry, Baldwin has your back.

AVAILABILITY

Quality and high performance are not enough. Baldwin delivers. With an extensive distribution network and an unmatched factory fill-rate, you can trust Baldwin has the filters you need, when and where you need them.



YOUR SINGLE, RELIABLE FILTER PARTNER

WHATEVER YOU'RE OPERATING

It's not just a job, it's a way of life. You count on your equipment for your livelihood. You need a filter you can trust. With a history deeply connected to farming, Baldwin has an in-depth understanding of the ag industry and a relentless focus on new, innovative filtration technologies to deliver heavy-duty protection for generations to come.

CASE-INTERNATIONAL AXIAL FLOW COMBINES

5140, 6140, 7140 w/FPT 8.7L ENG

BALDWIN	OE	DESCRIPTION
LUBE		
B7174-MPG	84346773	Maximum Performance Glass Lube Spin-on
B7327	84228488	Lube Spin-on
FUEL		
BF1365	84348882	Fuel/Water Separator Element
BF7696	84597064	Fuel Spin-on
BF7912	84477370	Box-Style Fuel Element
BF7922	84412164	Fuel Spin-on
AIR		
PA5668	360260A2	Cab Air Element
RS3544	84217229	Radial Seal Outer Air Element
RS3926	86998333	Radial Seal Outer Air Element
RS3927	86998332	Radial Seal Inner Air Element
HYDRAULIC		
BT8308-MPG	1329214C1, A177605	Maximum Performance Glass Hydraulic Spin-on

JOHN DEERE HILLMASTER COMBINES

S650 STS, S660 STS, S670, S670 STS w/POWERTECH PSX 9.0L ENG

BALDWIN	OE	DESCRIPTION
LUBE		
P7233	RE509672	Lube Element
AIR		
PA5696	RE284091	Cab Air Element
RS30009	HXE11091	Radial Seal Inner Air Element
RS30008	HXE11090	Radial Seal Outer Air Element
PA30117	L155288	Set of 2 Cab Air Elements
FUEL		
BF7929 KIT	RE525523	Set of 2 Fuel Filters
BF9866-O	RE539465	Fuel/Water Separator Spin-on
BF9917	RE533910	High Efficiency Fuel Spin-on
HYDRAULIC		
BT8852-MPG	AH128449	Maximum Performance Glass Hydraulic Element
PT9414-MPG (S670, S670 STS only)	AN207368	Maximum Performance Glass Hydraulic Element

JOHN DEERE TRACTORS

8285R, 8310R, 8360R w/POWERTECH PSX 9.0L ENG, 8295R, 8320R w/6090 POWERTECH PLUS ENG

BALDWIN	OE	DESCRIPTION
LUBE		
P7233	RE509672, RE538245	Lube Element
FUEL		
BF7929 KIT	RE525523	Set of 2 Fuel Filters
BF9866-O	RE539465	Fuel/Water Separator Spin-on with Open Port for Bowl
BF9917	RE533910	High Efficiency Fuel Spin-on
AIR		
PA5689	RE291412	Cab Air Element
PA5696	RE284091	Cab Air Element
RS5354	RE210102	Radial Seal Outer Air Element
RS5355	RE210103	Radial Seal Inner Air Element
HYDRAULIC		
BT8876-MPG	RE210857	Maximum Performance Glass Hydraulic Spin-on

MASSEY FERGUSON TRACTORS

7619, 7620, 7622, 7624 w/AGCO 66 CTA (6.6L) ENG (DYNA VT, DYNA STEP)

BALDWIN	OE	DESCRIPTION
LUBE		
B7179	V836662580	Lube Spin-on
FUEL		
BF1391-O	3905873M91	Fuel/Water Separator Spin-on with Open Port for Bowl
AIR		
CA5514	4286473M2	Channel Flow Pri. Air Element
PA5515	4286474M1	Channel Flow Sec. Air Element
PA5682	3786649M3	Cab Air Element
HYDRAULIC		
PT9395-MPG	72311028	Maximum Performance Glass Hydraulic Element
PT9530	72312070	Hydraulic Element

NEW HOLLAND COMBINES

CX5080, CX5090, CX8030, CX8040, CX8050, CX8060

BALDWIN	OE	DESCRIPTION
LUBE		
BT7237 (CX8030 only)	504074043	Lube Spin-on
BT7237 (CX5080, CX5090 only)	4897898	
FUEL		
BF7696 (CX8040, CX8050, CX8060 only)	504199551	Fuel Spin-on
BF7881	336430A1	Box-Style Fuel Filter
BF7966 (CX5080, CX5090, CX8030 only)	4897897	Fuel Spin-on
AIR		
RS3544 (Exc. CX5080, CX5090)	84036676, 87682993,	Radial Seal Outer Air Element
PA30126 (Exc. CX5080, CX5090)	84058793	Cab Air Element
RS30181	84072430	Inner Air Element
RS30182	84072431	Outer Air Element
HYDRAULIC		
BT8450 (CX5080, CX5090 only)	9814477	Hydraulic Spin-on
BT8850-MPG (Exc. CX5080, CX5090)	84074777	Maximum Performance Glass Hydraulic Spin-on
BT8851-MPG	81863799	Maximum Performance Glass Hydraulic Spin-on
BT8851-MPG (CX5090 only)	9821387	Maximum Performance Glass Hydraulic Spin-on

**HARD WORK
IT'S IN OUR BLOOD**

COVERAGE TO GET YOUR JOB DONE ON TIME

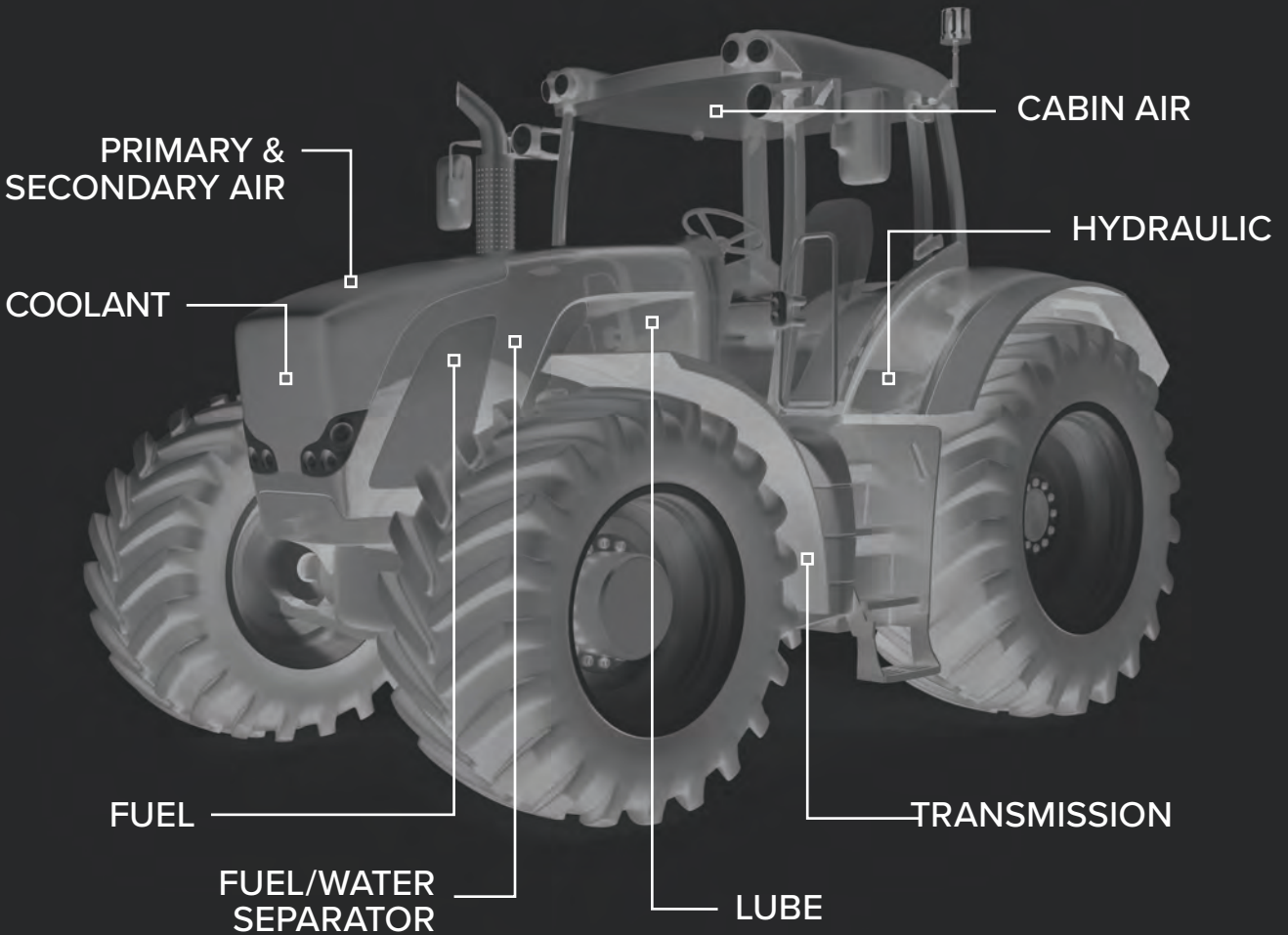

Your livelihood depends on your equipment – no matter what the job or what the conditions, you can be sure Baldwin has the protection tough jobs demand. With an extensive line of quality filtration products for all types of diesel trucks and equipment, we've got the coverage to be your single, reliable partner for all of your filtration needs.

PERFORMANCE TO KEEP YOU IN THE FIELDS

DURABLE PERFORMANCE

AIR

Baldwin air filters are as tough as they are efficient, ensuring uncompromised efficiency over the entire life of the filter. Durable designs protect your equipment under the harshest conditions.

RS30182

■ BALDWIN ■ OE

EFFICIENCY (%)

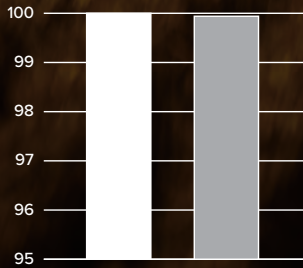

CAPACITY (g)

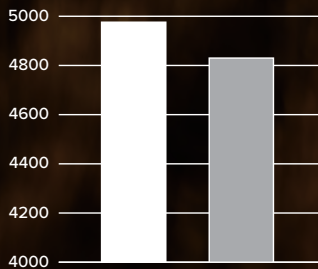

ISO 5011 Test: Flow Rate 1100 SCFM, ISO Fine Test Dust, Termination at 30" of water

For Fendt Combines; Massey Ferguson, New Holland Combines

Baldwin filters are vigorously tested above and beyond industry standards, ensuring reliable performance under the toughest conditions.

QUALITY TRUSTED FOR GENERATIONS

MAXIMUM CAPACITY LUBE

Baldwin lube filters are up to the challenge of providing both high capacity and the ability to withstand the rigors of time and temperature without losing efficiency.

B7174-MPG

■ BALDWIN ■ OE

CAPACITY (g)

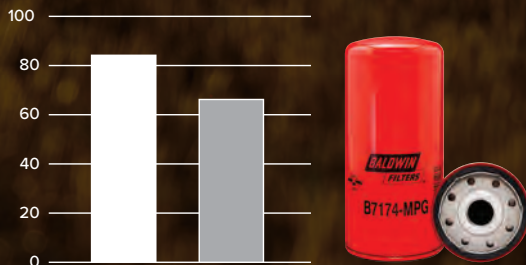

EFFICIENCY (%)

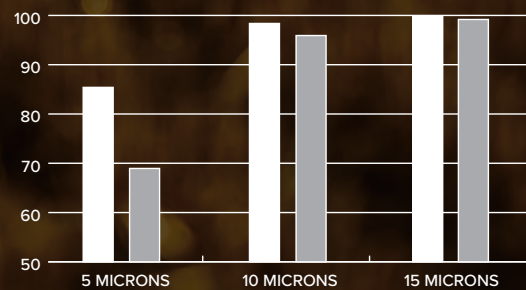

ISO 4548-12 Test: Flow Rate 20 gpm, ISO Medium Test Dust, 104°F, Termination at 20 psid

For Case-International, New Holland Combines, Tractors

OPTIMAL EFFICIENCY FUEL

Baldwin fuel filters keep fuel pristinely clean of even the smallest contaminants and enable precision, high pressure fuel systems to operate at maximum efficiency.

BF9917

■ BALDWIN ■ OE

CAPACITY (g)

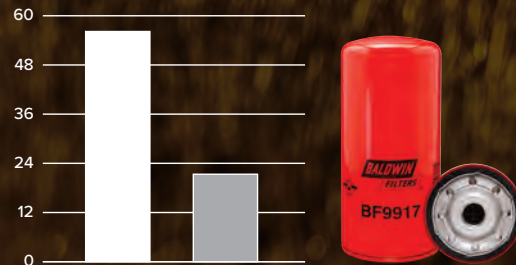

EFFICIENCY (%)

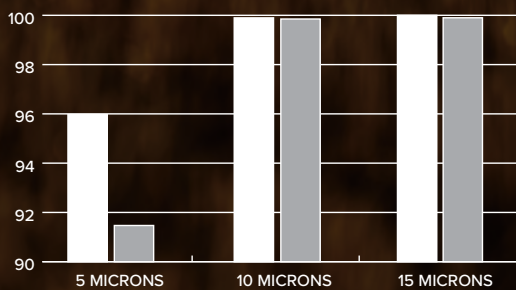

ISO 19438 Test: Flow Rate 3 gpm, ISO Medium Test Dust, 104°F, Termination at 5 psid

For John Deere Combines, Tractors and Sprayers



800.822.5394 | baldwinfilter.com

Designed and manufactured in the USA.

Form 620 (1/18) © 2018 Baldwin Filters, a Parker Hannifin Company



WARNING: These products can expose you to chemicals, including Diisononyl Phthalate, Carbon black extracts, Nickel, 1,3 Butadiene, Ethylene Oxide, Epichlorohydrin, which are known to the State of California to cause cancer, and Bisphenol-A, Ethylene Glycol, Ethylene Oxide, 1,3 Butadiene, Epichlorohydrin, which are known to the State of California to cause birth defects or other reproductive harm. For more information go to www.P65Warnings.ca.gov.